

amadeus

464-1805-80 / amadeus 180C

eumar

www.eumar.ee/120

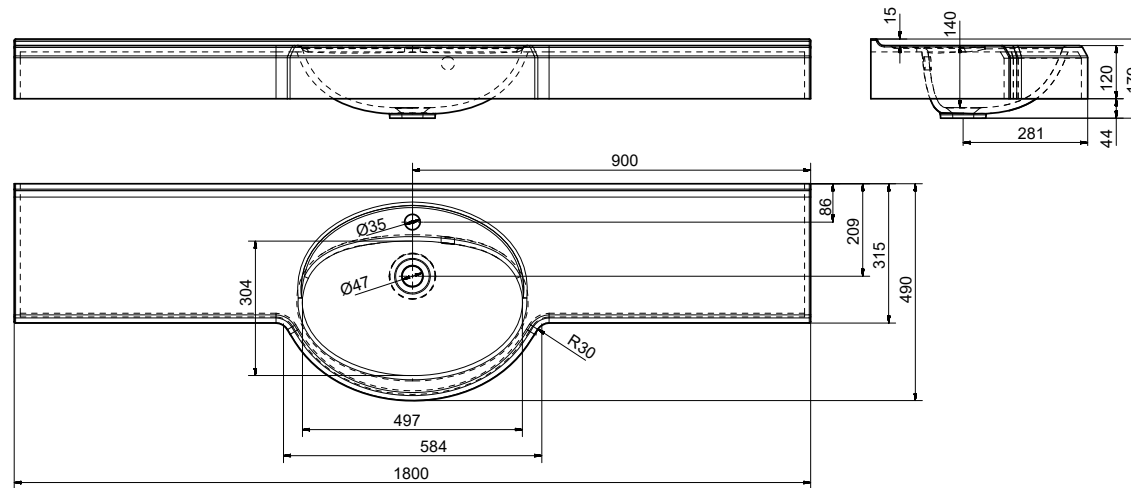

Price is for base-model and does not include functional openings, accessories and customizations. / Der Preis bezieht sich ausschließlich auf das Standard Modell. Nicht beinhaltet sind Öffnungen, Zubehörteile und Maßanfertigungen / *Prix indiqués pour les modèles de base, n'inclus pas les options, ouvertures, accessoires ni adaptations.*

All drawings contain necessary measurements, which are subject to standard tolerances. They are stated in mm and are non-binding. Exact measurements, in particular of customized products, can only be taken from the finished product. Information about tolerances can be found in our General Terms and Conditions (GTC) - www.eumar.ee/gtc In the interests of technical progress we reserve the right to introduce technical modifications.